

OUTDOOR LIGHTING

**THE BOOK OF IN-LITE**



**in-lite®**





make your outdoor space unique.



ENHANCES EVERYTHING OUTDOORS

# THE NICEST PLACE IN YOUR HOME IS THE GARDEN

Until night falls and all the joy it brings simply disappears. Outdoor lighting from in-lite lets you discover how your garden can really come to life after dark. Lighting makes your lovely garden a magical place. Your eye is drawn to the elements that are illuminated: an amazing tree, a wonderful lounging area or a colourful border. While everything blends together during the daytime, lighting lets you create personal accents and your own magical place after dark. We think everyone should experience this for themselves.

For around 25 years now in-lite has been developing the perfect light for outdoor spaces. This has resulted in some of the most true-to-life lighting available on the market. The system operates on a low voltage, making it easy and safe for anyone to install. The fixtures are fitted with high-quality LEDs, which translates into low energy consumption and light that is as natural and inviting as possible.

Everything from the tallest tree to the smallest plant can be attractively illuminated with in-lite products. And the in-lite app lets you easily switch your lighting on and off, resulting in maximum convenience and complete control. Both coloured lighting and dimming are possible, and you can create new effects, contrasts and different colour combinations. In no time at all, you can transform your outdoor space into a magical place that can be enjoyed into the small hours, with in-lite enhancing everything outdoors.





# CONTENTS

## CONCEPTS

SWAY	12
ACE	14
EVO	16

## INNOVATION

18

## PRODUCTS

recessed lights	20
outdoor spots	36
line light	48
bollards	54
wall lights	66
ceiling lights	80

## PARTNERS

88

## SYSTEM

90

SMART LIGHTING

## SMART TONE PRODUCTS

PAGE 28 | 42 | 52



PREVIEW

NEW  
IN 2024





# MORE THAN A BRAND

in-lite is more than just an outdoor lighting brand. We're a company with a mission. This is done by developing beautiful outdoor lighting fixtures but above all by inspiring as many people as possible and showing that lighting belongs in every outdoor space. But that's not all we do. An extensive network of partners and landscapers have the exact same mission. We train these professionals in the in-lite Playground and inspire them with unique ways to use lighting. Together we make any outdoor space a unique place that you can fully enjoy well into the evening hours.



## EASY TO INSTALL

- Easy to install
- Safe for humans and animals
- 100% waterproof system



## QUALITY & DESIGN

- Suitable for any garden
- European design
- 5-year warranty



## THE PERFECT LIGHT

- Elegant warm white light
- The most beautiful colours and contrasts
- Sustainable and energy-efficient



## SMART

- in-lite app
- Focus on simplicity
- Pioneering and innovative

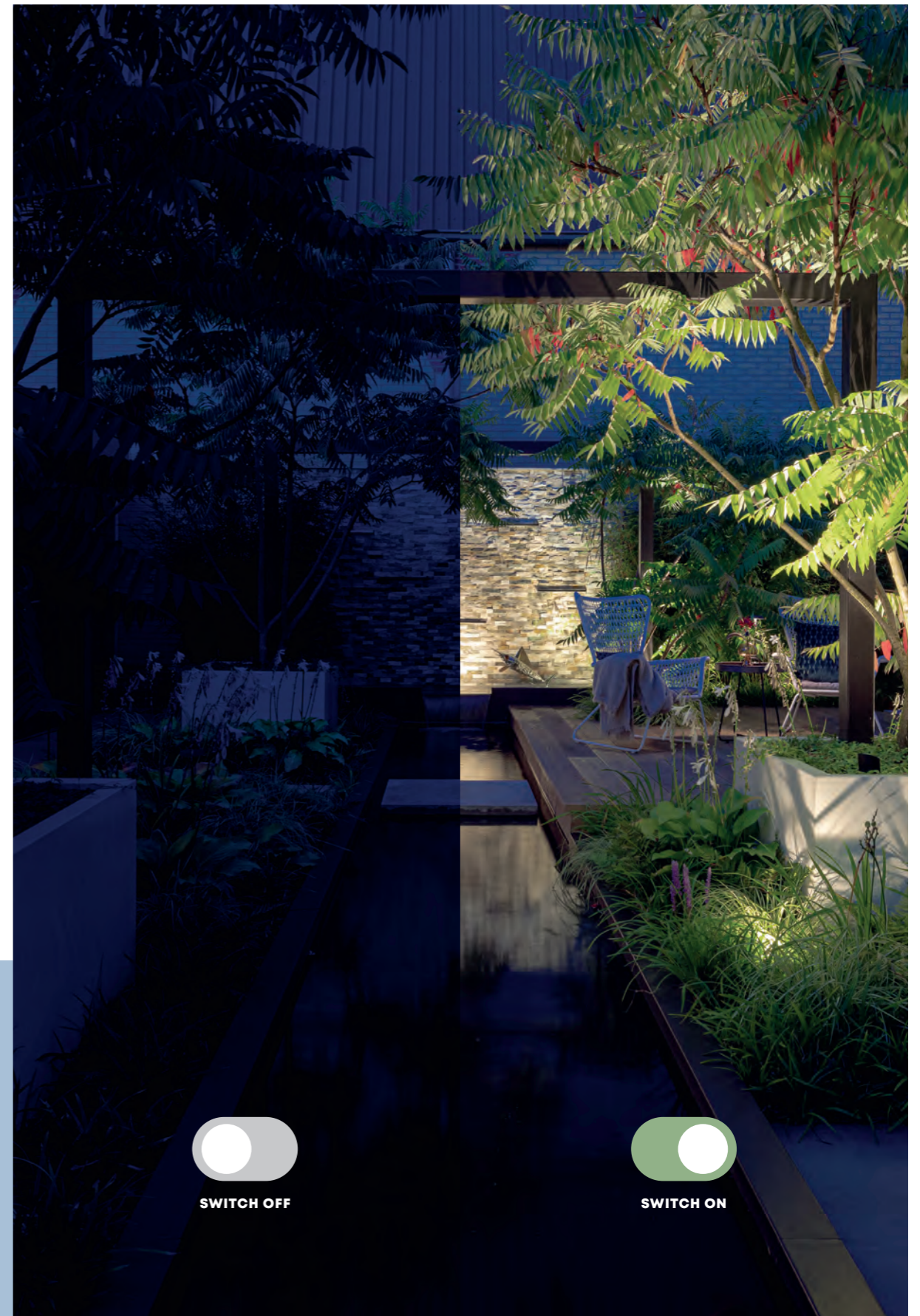

You can also follow us at [@inlite\\_global](https://www.instagram.com/inlite_global)





INNOVATION

# SMART LIGHTING

At its core, in-lite's Smart system comprises a SMART HUB and the in-lite app. The smart transformer enables you to connect up any fixture from in-lite's range and control each line using a Bluetooth Low Energy connection. Next add (individually controllable) Smart lights, such as SMART SCOPE TONE, SMART FLUX TONE and SMART EVO FLEX TONE. Thus transforming your garden into a colourful, elegant whole.

Ease of use is key to the in-lite app. Setting routines is straightforward and allows you to decide what time the lights will turn on and off. You can also add the SMART MOVE wireless motion detector or an accessory like the SMART BRIDGE. This enables you to integrate your Bluetooth system into your WiFi network, giving you control over your lighting anytime, anywhere. The in-lite Smart system can also be integrated into home automation systems such as Google Home, Apple HomeKit and Amazon Alexa.

Smart lighting is the future of our range. The in-lite app is continuously developing, enabling us to permanently offer Smart system users new options and optimisations such as in-lite Scenes and in-lite Energy Insight – a bespoke sustainability plan for your garden.

Keen to find out more about in-lite Smart and be kept informed of all developments? Scan the QR code.

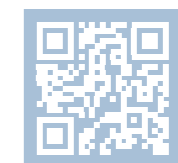
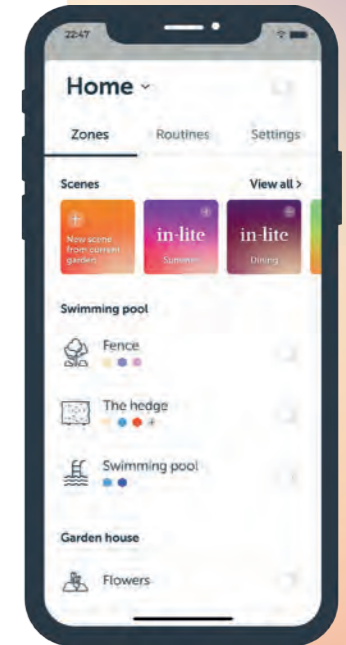



# CREATING GARDENS

## IN PHASES

The unique in-lite system makes it possible to expand your lighting step by step. You start by installing a sufficient number of cables in the garden and over time, you simply add new fixtures as desired. Your dream garden will be a reality in no time!

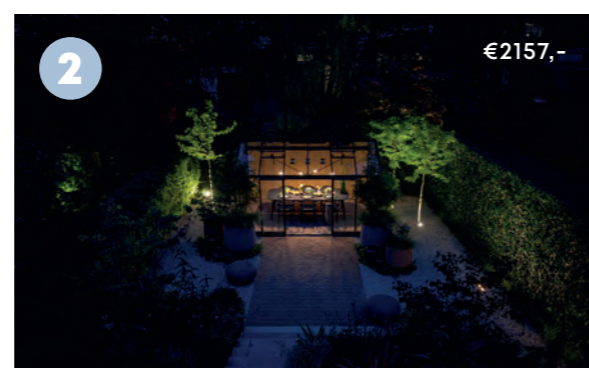
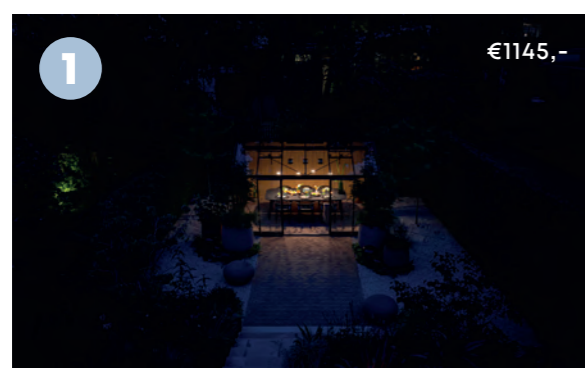



IN-LITE CONCEPT

# SWAY

## ONE WITH NATURE

The concept encompasses bollards, wall lights, hanging lights in two different colours (Black and Pearl Grey) and a table light. The idea underlying the design is that a fixture can be in harmony with the garden and hence does not always need to stand out. The minimalistic design gives rise to an elegant, friendly appearance that is very contemporary.



p. 84



p. 56

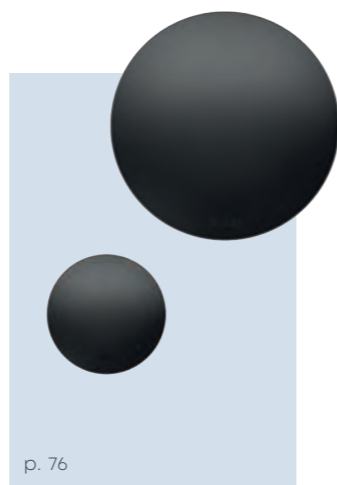

p. 76







p. 59

IN-LITE CONCEPT

# ACE



## PERFECT SPACE

The concept encompasses bollards and wall lights in four different colours: Dark Grey, White, Rosé Silver and Corten. Anyone can benefit from this concept. The design is minimalistic and the light produces distinctively sleek illumination.

p. 68



p. 68



p. 68



IN-LITE CONCEPT

# EVO

## PERFECT EVOLUTION

The concept encompasses bollards, wall lights, RECESSED and line lighting. EVO stands for design and premium quality. The fixtures sport an architectural design which fits in perfectly in gardens with sharp lines and high-quality materials.



p. 63

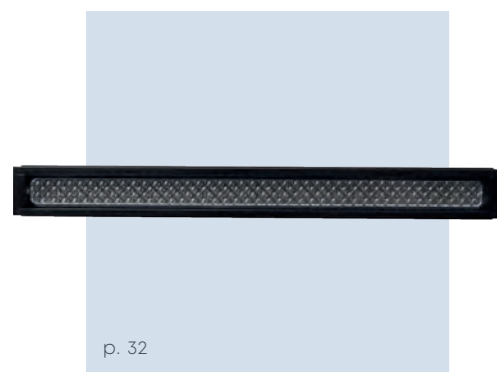

p. 32

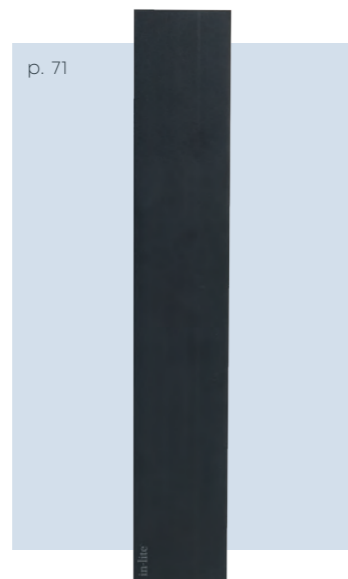

p. 71

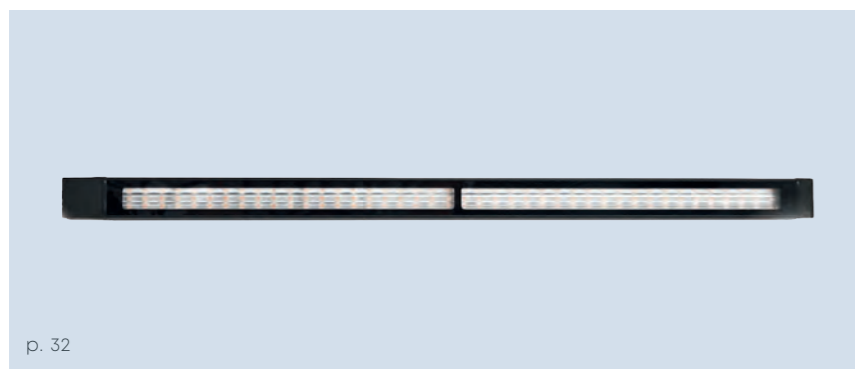

p. 32



Interested in discovering more in-lite concepts such as VOQUE and DISC? See [in-lite.com/en/concepts](http://in-lite.com/en/concepts).





# INNOVATION

## BY IN-LITE

in-lite designs and produces all its products itself. Throughout the design process we examine the options in the garden and what lighting solution is required to provide perfect illumination. Moreover, our fundamental principle is to keep our products as simple as possible. And simple products call for innovative ideas.

## MODULAR DESIGN

Various fixtures and concepts in the in-lite range have a modular structure. This approach ensures that you have maximum freedom and can put together your end product yourself. Combinations of product colour and fixture height are possible.

We take things one step further with AIM, our newest series of designer spots. Here, we have developed a patent-pending method that allows light sources to be literally stacked. Thus enabling you to decide for yourself whether you would like to use AIM with one, two or three light sources. Offering the user maximum flexibility and expandability.



## in-lite | human dimming

in-lite Human Dimming allows you to dim fixtures manually without having to touch them. This technology features in various hanging lights and SWAY TABLE, the wireless table light.

## in-lite | motion

in-lite Motion stems from the need to be able to tilt a light source without having to open the fixture. Thus preventing moisture issues and preserving maximum functionality. This applies to BIG NERO. Placing a magnet on the light source enables you to tilt the light source and create your desired illumination yourself.





PRODUCT GROUP

# RECESSED LIGHTS

## PUCK

Light intensity: low

## FUSION

Light intensity: low

## HYVE

Light intensity: medium

## DB LED

Light intensity: medium

## LUNA

Light intensity: high

## FLUX

Light intensity: high

## NERO

Light intensity: high

## EVO FLOOD

Light intensity: high

## EVO GROUP

Light intensity: low

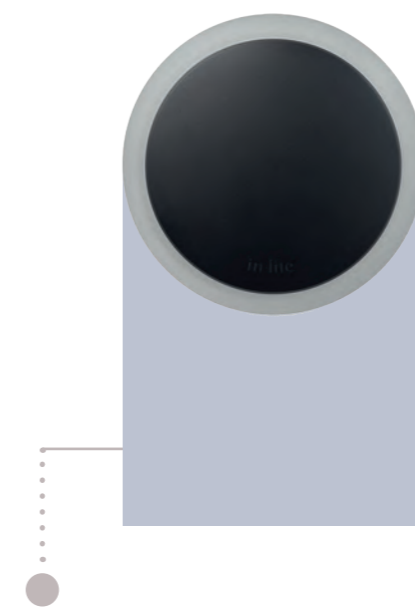
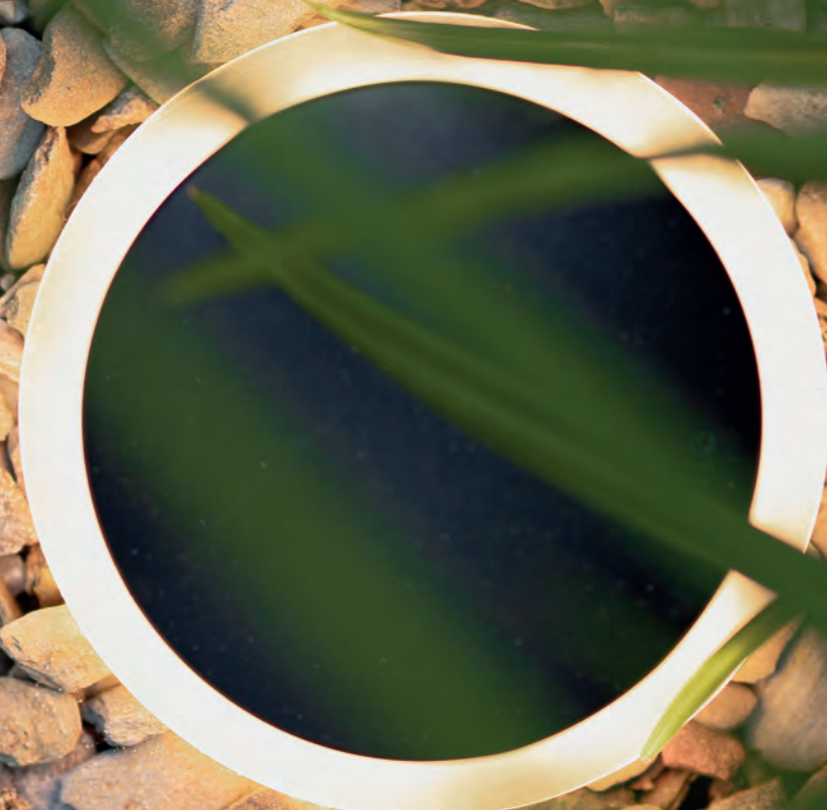

## PUCK

Capacity 1,50 W  
Installation value 2,50 VA  
Colour temperature 2900 K  
CRI 96  
IP 67  
Size ø60 mm  
Colour ■ ■

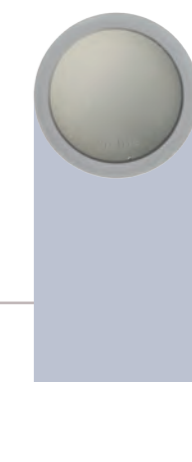

## PUCK 22

Capacity 0,60 W  
Installation value 0,60 VA  
Colour temperature 2900 K  
CRI 96  
IP 67  
Size ø22 mm  
Colour ■ ■





### HYVE 22

Capacity 0,20 W  
 Installation value 0,20 VA  
 Colour temperature 3100 K  
 CRI 93  
 IP 67  
 Size ø22 mm



### HYVE 22 STAINLESS STEEL

Capacity 0,20 W  
 Installation value 0,20 VA  
 Colour temperature 3000 K  
 CRI 95  
 IP 67  
 Size ø22 mm  
 Colour ■



### HYVE

Capacity 0,80 W  
 Installation value 0,80 VA  
 Colour temperature 3000 K  
 CRI 95  
 IP 67  
 Size ø60 mm  
 Colour ■



### FUSION 22

Capacity 0,20 W  
 Installation value 0,20 VA  
 Colour temperature 2750 K  
 CRI 93  
 IP 67  
 Size ø22 mm



### FUSION 22 STAINLESS STEEL

Capacity 0,20 W  
 Installation value 0,20 VA  
 Colour temperature 2750 K  
 CRI 94  
 IP 67  
 Size ø22 mm  
 Colour ■



### FUSION

Capacity 0,90 W  
 Installation value 1,00 VA  
 Colour temperature 2650 K  
 CRI 93  
 IP 67  
 Size ø60 mm  
 Colour ■







### DB LED (WW)

Capacity	0,50 W
Installation value	0,50 VA
Colour temperature	2850 K
CRI	94
IP	67
Size	ø22 mm



CHOOSE FROM  
THE VARIOUS  
COLOUR RINGS.



### LUNA

Capacity	3,00 W
Installation value	5,00 VA
Colour temperature	3100 K
CRI	94
IP	67
Size	ø60 mm
Colour	<input type="checkbox"/> <input type="checkbox"/> <input type="checkbox"/>

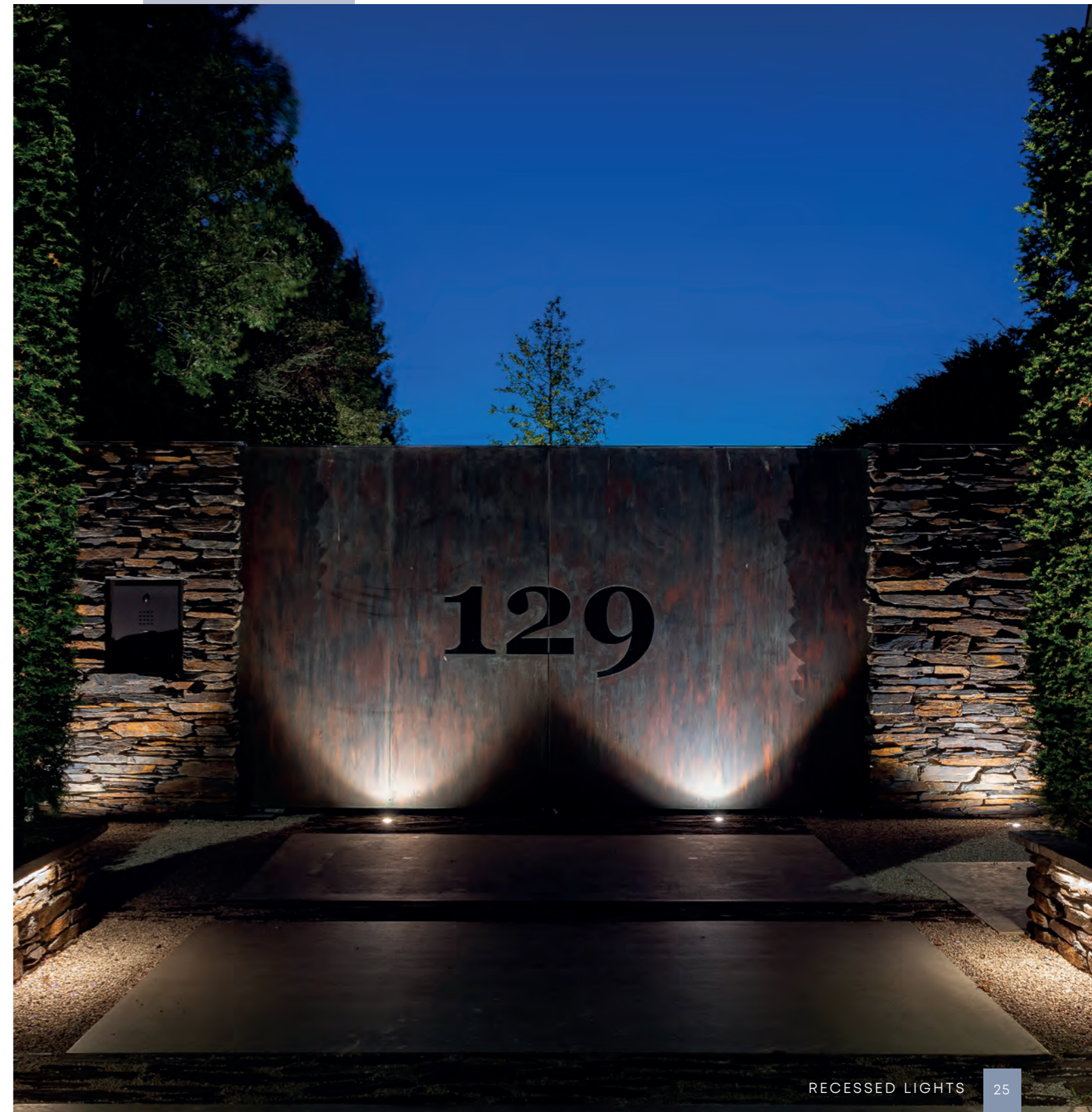





### BIG FLUX

Capacity 3,00 W  
 Installation value 4,20 VA  
 Colour temperature 3100 K  
 CRI 93  
 IP 68  
 Size ø60 mm  
 Colour



### BIG FLUX ASYMMETRIC

Capacity 3,00 W  
 Installation value 4,20 VA  
 Colour temperature 3100 K  
 CRI 93  
 IP 68  
 Size ø60 mm  
 Colour

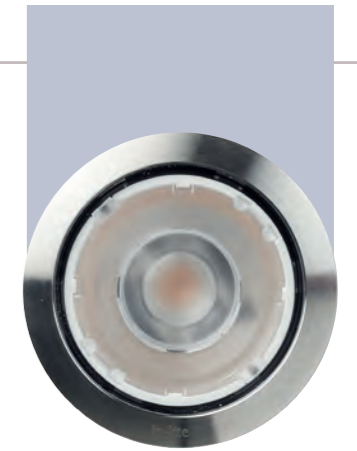

### BIG FLUX NARROW

Capacity 3,00 W  
 Installation value 4,20 VA  
 Colour temperature 3100 K  
 CRI 93  
 IP 68  
 Size ø60 mm  
 Colour

### FLUX

Capacity 1,50 W  
 Installation value 2,50 VA  
 Colour temperature 3000 K  
 CRI 92  
 IP 67  
 Size ø60 mm  
 Colour

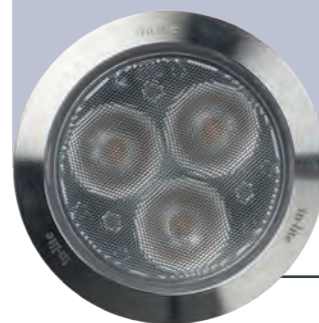

**INCORPORATING INTO GRASS, SAND OR GRAVEL?**  
 Use accessory SPIKE.





# SMART FLUX TONE

## SMART FLUX TONE

is the first ground spot in the Tone line, making it a great addition to the Smart collection. This ground spot combines well with the other smart lighting and the settings are easily adjusted using the in-lite app.



CHOOSE FROM  
THE VARIOUS  
COLOUR RINGS.

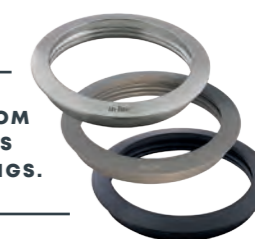

## SMART FLUX TONE

Capacity	6,00 W
Installation value	9,5 VA
Colour temperature	3100 K
IP	67
Size	ø60 mm
Colour	







**NERO**

Capacity 3,00 W  
 Installation value 4,70 VA  
 Colour temperature 3100 K  
 CRI 91  
 IP 67  
 Size ø116 mm

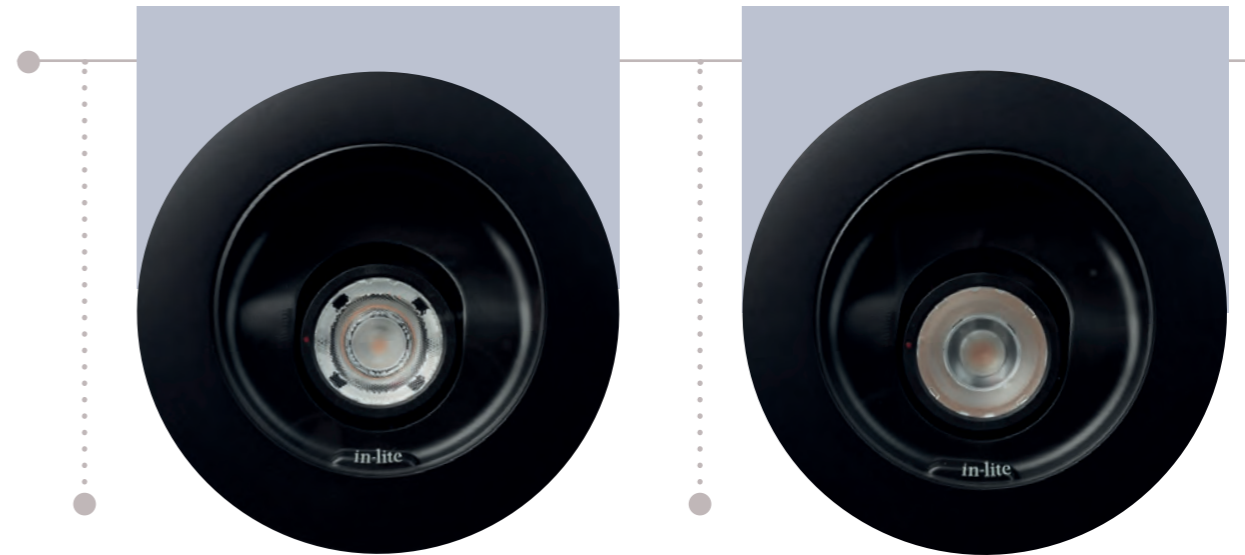

**BIG NERO**

Capacity 7,50 W  
 Installation value 11,90 VA  
 Colour temperature 3100 K  
 CRI 90  
 IP 67  
 Size ø142 mm

**in-lite** | motion

**BIG NERO NARROW**

Capacity 7,50 W  
 Installation value 11,90 VA  
 Colour temperature 3100 K  
 CRI 91  
 IP 67  
 Size ø142 mm

**in-lite** | motion





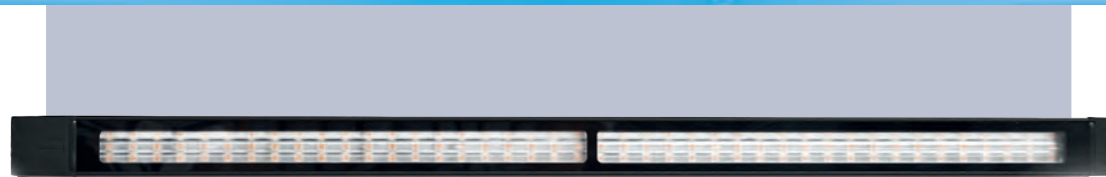

### EVO FLOOD

Capacity 5 W  
 Installation value 8 VA  
 Colour temperature 2800 K  
 CRI 97  
 Length 438 mm  
 Colour ■



### EVO GROUND 300

Capacity 1,00 W  
 Installation value 1,00 VA  
 Colour temperature 3000 K  
 CRI 95  
 IP 67  
 Length 300 mm  
 Colour ■





# RECESSED LIGHT

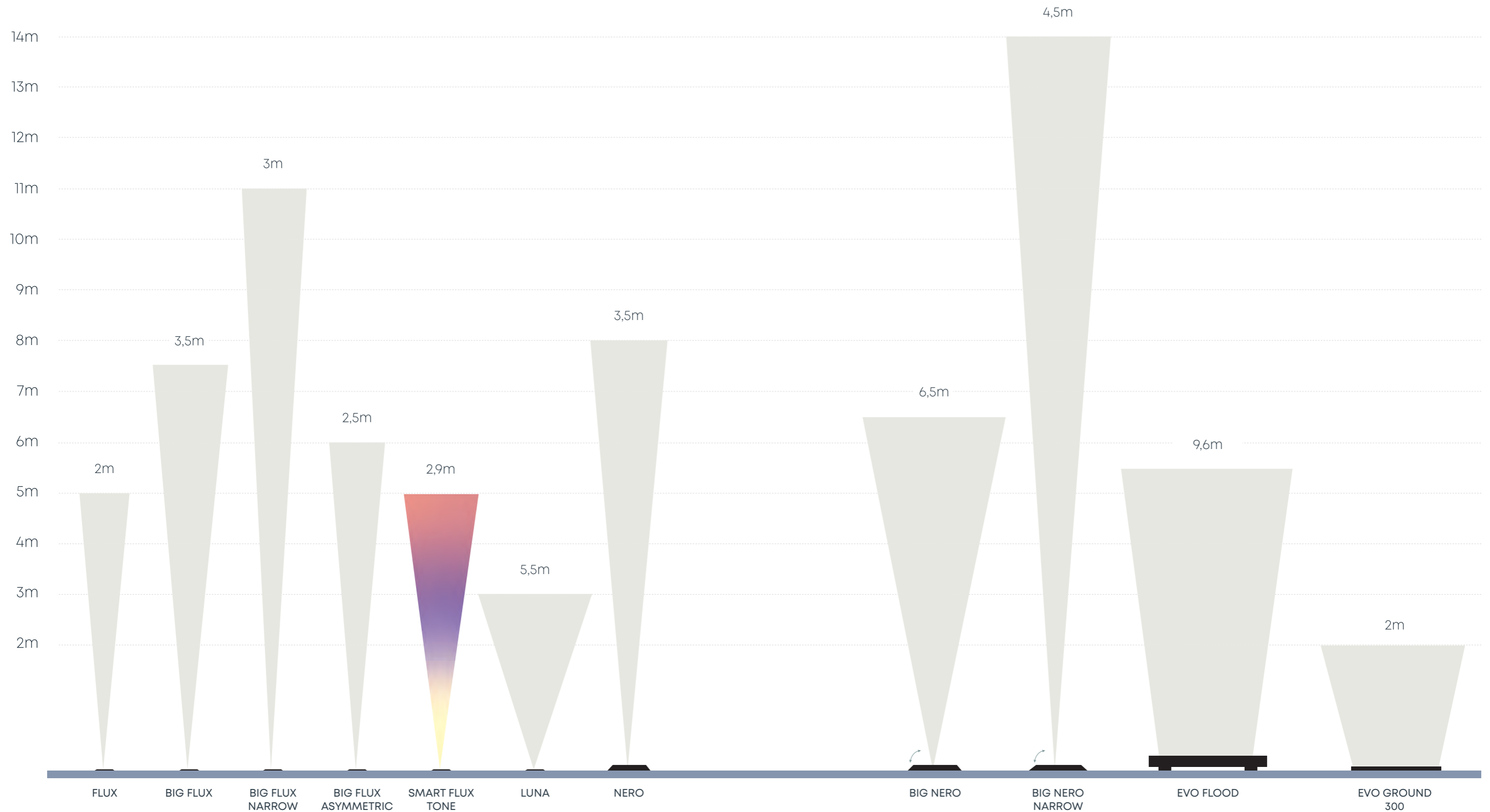



PRODUCT GROUP

# OUTDOOR SPOTS

## AIM

Light intensity: medium

## MICRO SCOPE

Light intensity: low

## MINI SCOPE

Light intensity: medium

## SCOPE

Light intensity: high

## BIG SCOPE

Light intensity: high

## SMART SCOPE TONE

Light intensity: high

## MINI SCOPE DUO

Light intensity: low

## SUB

Light intensity: medium

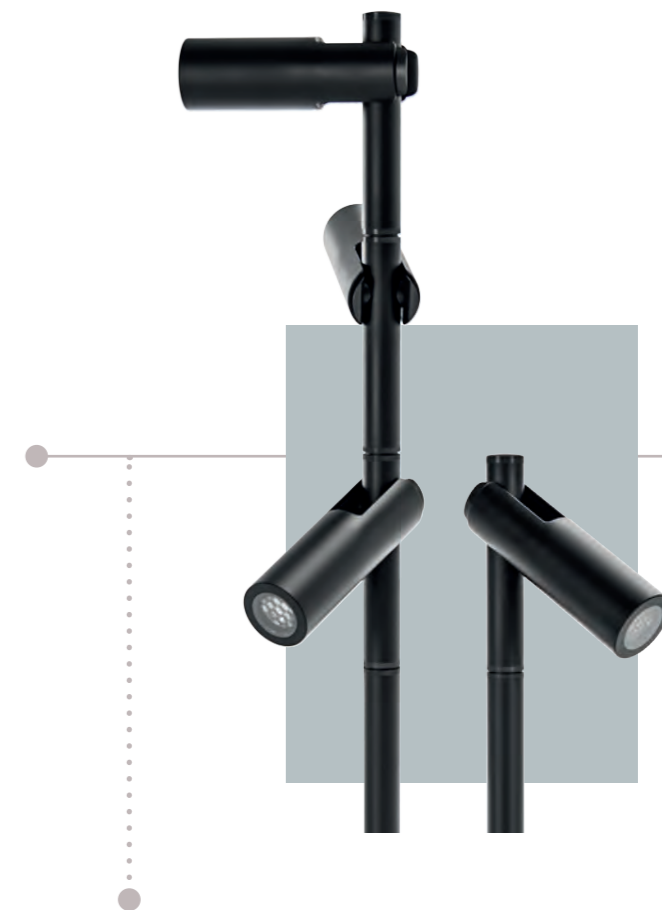

## AIM

Capacity	1,20 W
Installation value	2,10 VA
Colour temperature	3000 K
CRI	95
IP	67
Height	160 mm   400 mm   800 mm

\*Can be put together with individual light sources.





### MICRO SCOPE

Capacity 0,60 W  
 Installation value 1,10 VA  
 Colour temperature 2900 K  
 CRI 91  
 IP 67  
 Height 165mm



### MINI SCOPE

Capacity 1,00 W  
 Installation value 2,00 VA  
 Colour temperature 2900 K  
 CRI 93  
 IP 67  
 Height 215mm







Combine various SCOPE fixtures for lighting different heights and shapes. Use SCOPE for medium-sized trees, BIG SCOPE for wide, multistemmed trees and BIG SCOPE NARROW for the tallest treetops.



**SCOPE**

Capacity	3,00 W
Installation value	5,20 VA
Colour temperature	3100 K
CRI	91
IP	67
Height	256 mm



**BIG SCOPE**

Capacity	5,20 W
Installation value	8,00 VA
Colour temperature	3100 K
CRI	91
IP	67
Height	267 mm



**BIG SCOPE NARROW**

Capacity	5,00 W
Installation value	7,90 VA
Colour temperature	3100 K
CRI	92
IP	67
Height	267 mm

**INCORPORATING BETWEEN PLANTS?**  
Use accessory RISER.





# SMART SCOPE TONE

## SMART SCOPE TONE

is easy to set using the in-lite app. Apart from choosing different colours, the light intensity can also be adjusted.



## SMART SCOPE TONE

Capacity	6,00 W
Installation value	9,50 VA
Colour temperature	3100 K
IP	67
Height	267 mm







**MINI SCOPE DUO**

Capacity 2,00 W  
 Installation value 4,00 VA  
 Colour temperature 2900 K  
 CRI 93  
 IP 67  
 Height 800 mm



SUB is an underwater spot, suitable for lighting ponds or pond elements.



**SUB**

Capacity 3,00 W  
 Installation value 4,70 VA  
 Colour temperature 3000 K  
 CRI 93  
 IP 68  
 Height 150 mm



# OUTDOOR SPOT LIGHT

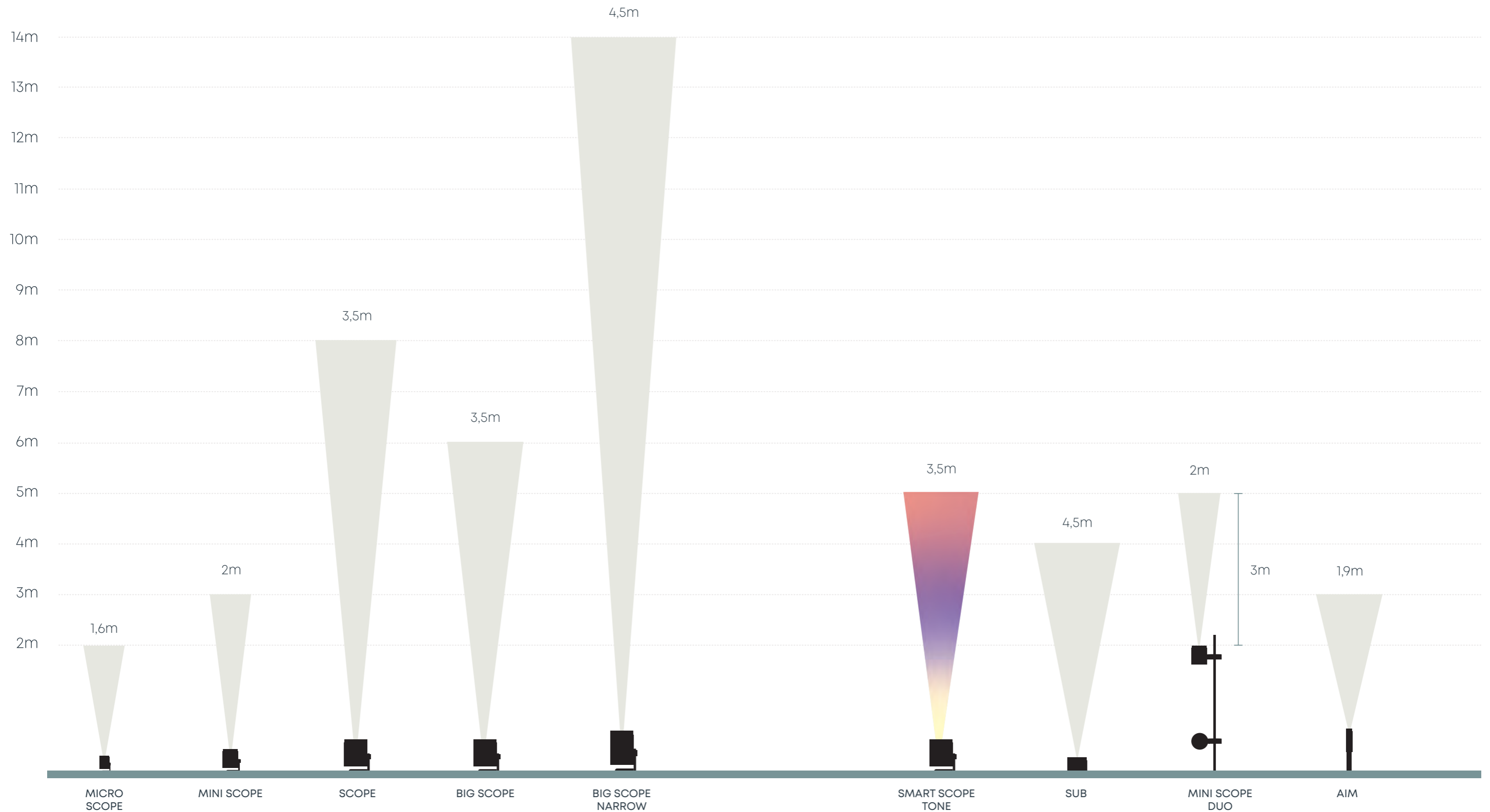



PRODUCT GROUP

# LINE LIGHTING

## EVO HYDE

Light intensity: low

## EVO FLEX

Light intensity: high

## SMART EVO FLEX

Light intensity: medium

## SMART EVO FLEX TONE

Light intensity: medium

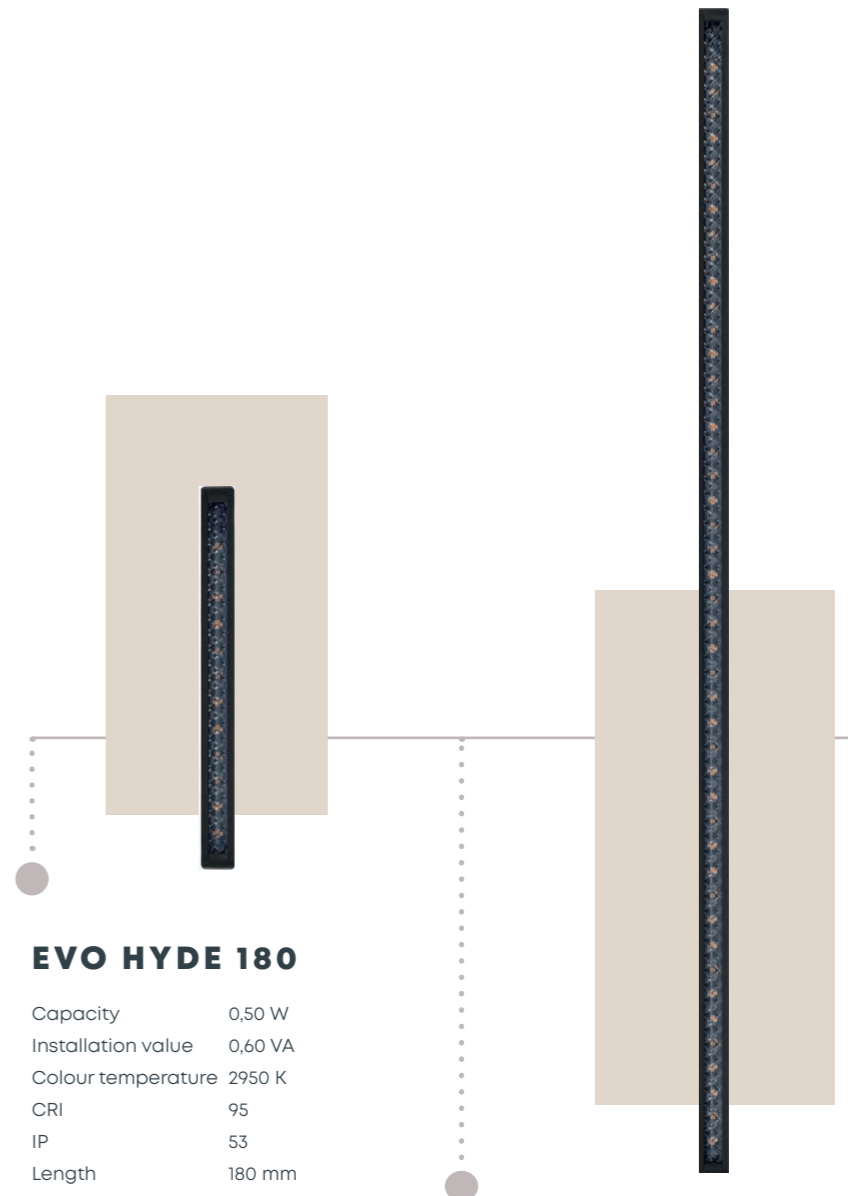

## EVO HYDE 180

Capacity	0,50 W
Installation value	0,60 VA
Colour temperature	2950 K
CRI	95
IP	53
Length	180 mm

## EVO HYDE 550

Capacity	2,00 W
Installation value	2,10 VA
Colour temperature	2950 K
CRI	93
IP	55
Length	550 mm



Prefer sleek or organic?  
 The flexible shape of EVO  
 FLEX makes anything  
 possible. The Smart variant  
 is dimmable using the  
 in-lite app. Available in  
 1, 2 and 3-metre variants.



**EVO FLEX**  
**SMART EVO FLEX**

Capacity 2,50 | 4,50 | 10,00 W  
 Installation value 4,50 | 7,50 | 14,50 VA  
 Colour temperature 3100 K  
 CRI 95  
 IP 68  
 Available in 1, 2 and 3-metre variants

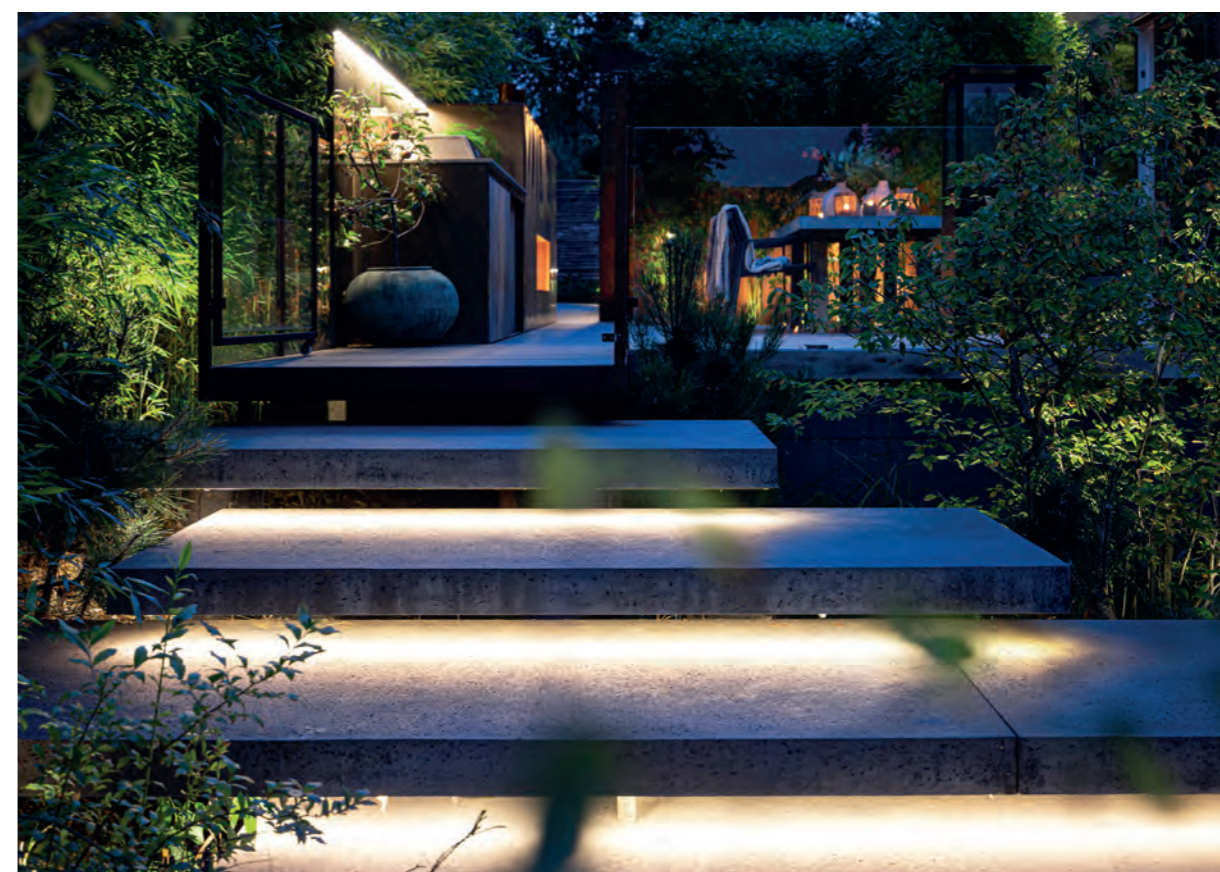



# SMART EVO FLEX TONE

## SMART EVO FLEX TONE

This fixture produces perfectly even line lighting without any visible light points. Fitted with dimmable colours Available in 1, 2 and 5-metre variants.



## SMART EVO FLEX TONE

Capacity 2,50 | 4,50 | 10,00 W  
Installation value 4,50 | 7,50 | 14,50 VA  
Colour temperature 3100 K  
CRI 95  
IP 68  
Available in 1, 2 and 5-metre variants





PRODUCT GROUP

# BOLLARDS

## SWAY TABLE

Light intensity: high

## SWAY

Light intensity: medium

## ACE

Light intensity: low

## LIV

Light intensity: medium

## DISC

Light intensity: medium

## EVO

Light intensity: medium

## VOQUE

Light intensity: medium



## SWAY TABLE

Capacity	1,80 W
Installation value	1,80 VA
Colour temperature	2900 K
CRI	96
IP	55
Height	345 mm

in-lite | human dimming



## MINI SWAY SWAY

Capacity	0,50 W   1,00 W
Installation value	0,60 V   1,00 V
Colour temperature	2900 K
CRI	95
IP	55
Colour	■ ■
Height	35 cm   60 cm   100 cm

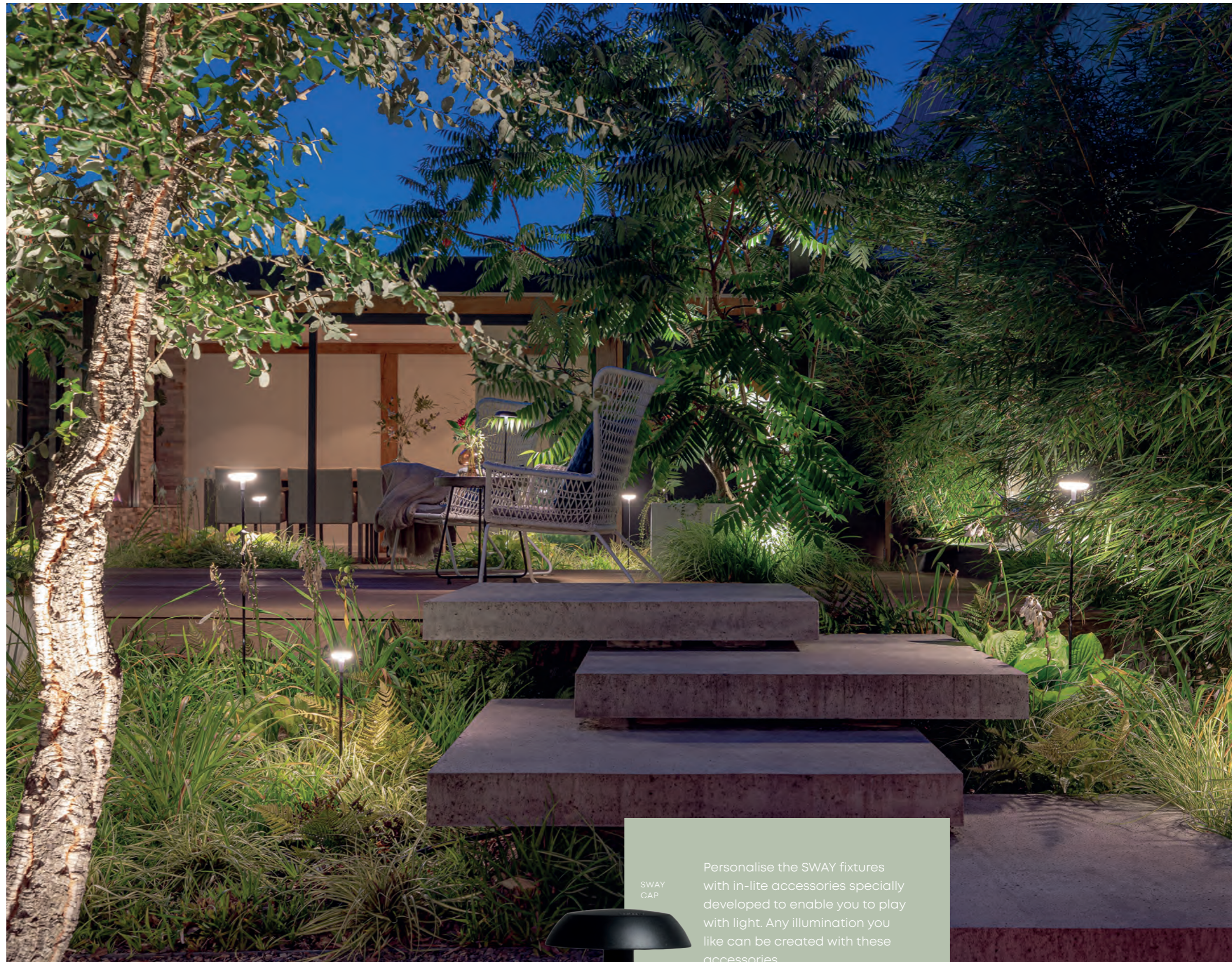

SWAY  
CAP

Personalise the SWAY fixtures with in-lite accessories specially developed to enable you to play with light. Any illumination you like can be created with these accessories.





**ACE  
ACE HIGH**

Capacity	3,00 W
Installation value	5,30 VA
Colour temperature	3000 K
CRI	94
IP	55
Colour	



WINK is a lens cap that can easily be placed on the ACE light source to stop people from looking straight into the light source and to adjust the illumination.





**LIV LOW  
LIV**

Capacity	1,50 W
Installation value	2,50 VA
Colour temperature	2900 K
CRI	95
IP	55
Colour	<span style="display: inline-block; width: 10px; height: 10px; background-color: #ccc; border: 1px solid #000;"></span> <span style="display: inline-block; width: 10px; height: 10px; background-color: #333; border: 1px solid #000;"></span> <span style="display: inline-block; width: 10px; height: 10px; background-color: #666; border: 1px solid #000;"></span> <span style="display: inline-block; width: 10px; height: 10px; background-color: #999; border: 1px solid #000;"></span>
Height	372 mm   612 mm

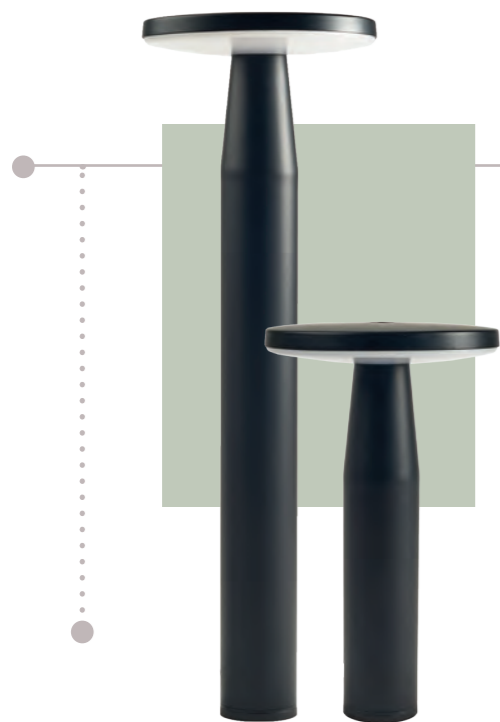

**DISC LOW  
DISC**

Capacity	3,00 W
Installation value	4,90 VA
Colour temperature	2900 K
CRI	98
IP	55
Colour	<span style="display: inline-block; width: 10px; height: 10px; background-color: #333; border: 1px solid #000;"></span>
Height	350 mm   600 mm

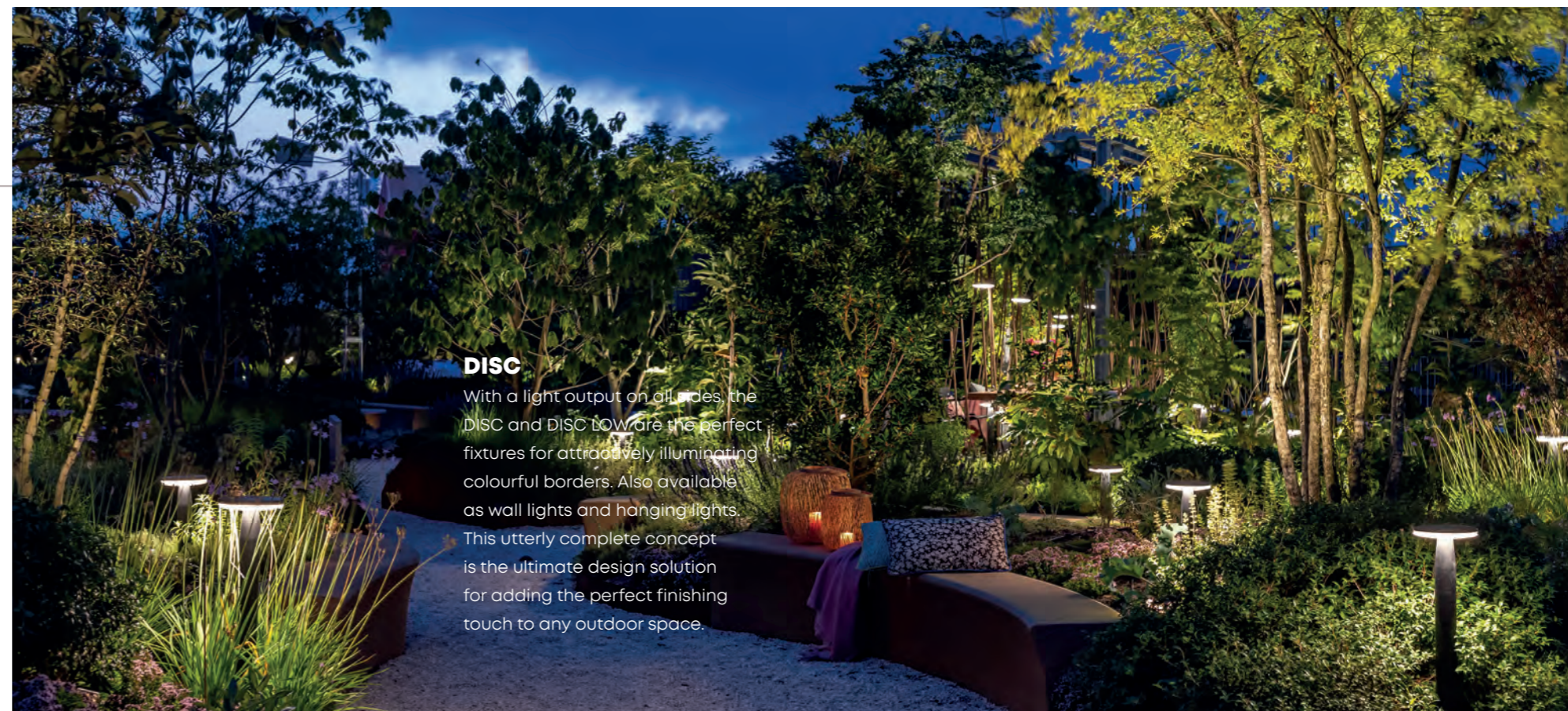

**DISC**

With a light output on all sides, the DISC and DISC LOW are the perfect fixtures for attractively illuminating colourful borders. Also available as wall lights and hanging lights. This utterly complete concept is the ultimate design solution for adding the perfect finishing touch to any outdoor space.





**EVO  
EVO LOW**

Capacity	2,00 W
Installation value	2,10 VA
Colour temperature	2950 K
CRI	95
IP	55
Colour	■
Height	366 mm   606 mm







.....● **VOQUE  
BIG VOQUE**

Capacity 3,00 W | 5,00 W  
 Installation value 5,20 VA | 8,00 VA  
 Colour temperature 2750 K  
 CRI 89  
 IP 55  
 Size ø300 | ø450 mm



.....● **VOQUE LOW  
VOQUE HIGH**

Combine TRIPOD with VOQUE and BIG VOQUE and experiment with different heights.  
 TRIPOD 1 350 mm  
 TRIPOD 2 735 mm





PRODUCT GROUP

# WALL LIGHTS

## DISC

Light intensity: low

## ACE

Light intensity: high

## CUBID

Light intensity: low

## EVO

Light intensity: high

## HALO

Light intensity: high

## WEDGE

Light intensity: medium

## SWAY

Light intensity: low

## BLINK

Light intensity: medium

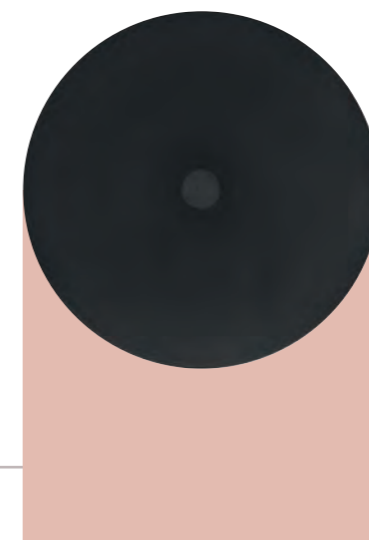

### DISC WALL

Capacity 3,00 W  
Installation value 4,90 VA  
Colour temperature 2900 K  
CRI 98  
IP 55  
Colour ■  
Size ø200 mm

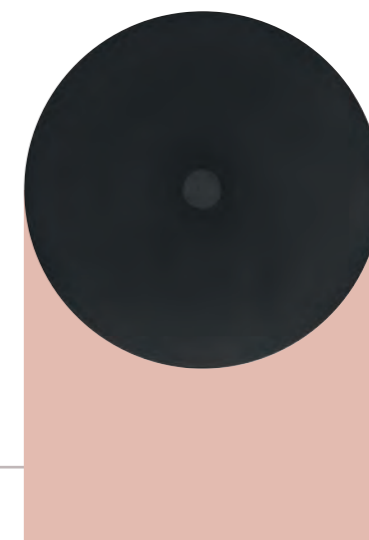

### DISC WALL 100-230V

Capacity 4,50 W  
Installation value 4,70 VA  
Colour temperature 2900 K  
CRI 98  
IP 55  
Colour ■  
Size ø200 mm

\*This fixture is dimmable



### ACE DOWN

Capacity	3,00 W
Installation value	5,30 VA
Colour temperature	3000 K
CRI	91
IP	55
Colour	
Height	100 mm



### ACE DOWN 100-230V

Capacity	4,50 W
Installation value	11,80 VA
Colour temperature	3000 K
CRI	95
IP	55
Colour	
Height	100 mm

\*This fixture is dimmable



### ACE UP-DOWN

Capacity	6,50 W
Installation value	10,30 VA
Colour temperature	3000 K
CRI	92
IP	55
Colour	
Height	120 mm



### ACE UP-DOWN 100-230V

Capacity	8,50 W
Installation value	20,00 VA
Colour temperature	3000 K
CRI	92
IP	55
Colour	
Height	100 mm

\*This fixture is dimmable





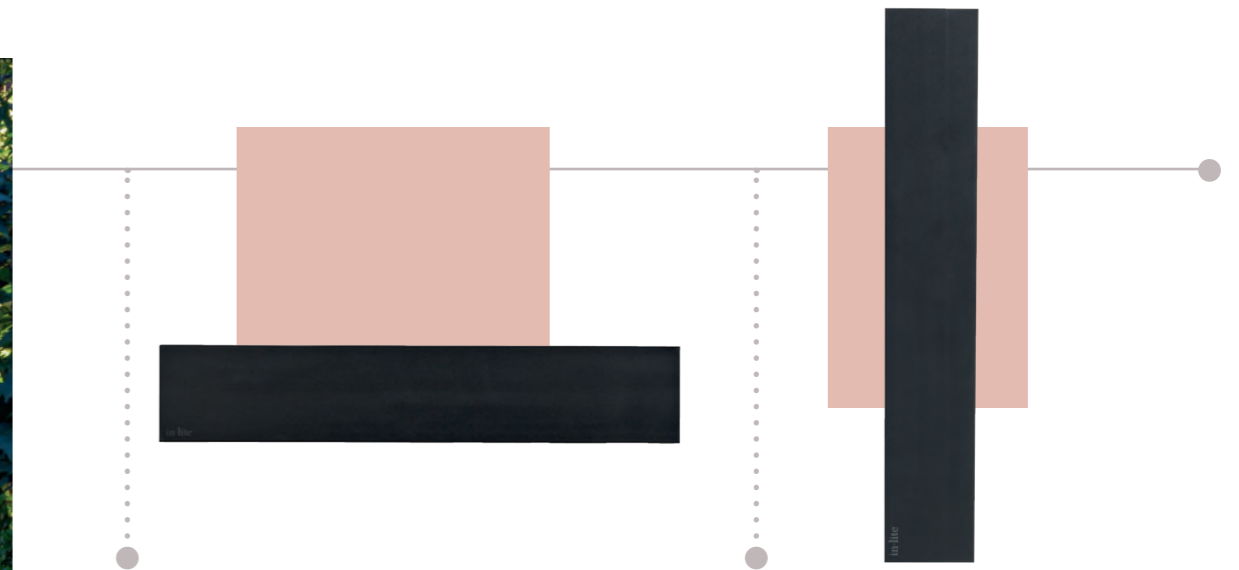

**EVO DOWN**

Capacity 2,00 W  
 Installation value 2,10 VA  
 Colour temperature 2950 K  
 CRI 95  
 IP 53  
 Colour ■  
 Width 520 mm

**EVO DOWN 100-230v**

Capacity 4,50 W  
 Installation value 11,50 VA  
 Colour temperature 3000 K  
 CRI 92  
 IP 55  
 Colour ■  
 Height 300 mm

\*This fixture is dimmable

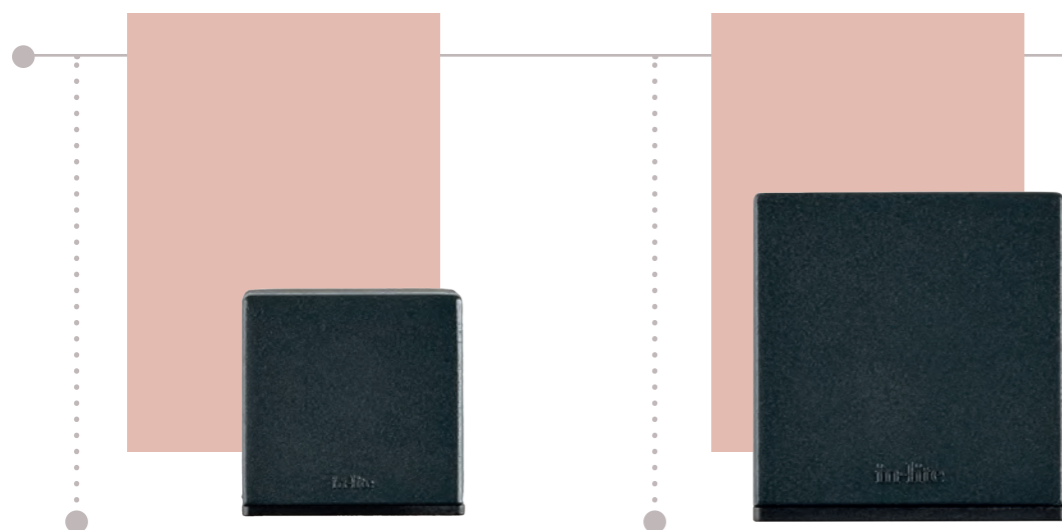

**CUBID**

Capacity 0,60 W  
 Installation value 0,60 VA  
 Colour temperature 2800 K  
 CRI 93  
 IP 55  
 Colour ■ ■ ■  
 Height 50 mm

**BIG CUBID**

Capacity 1,00 W  
 Installation value 2,00 VA  
 Colour temperature 2900 K  
 CRI 93  
 IP 55  
 Colour ■ ■ ■  
 Height 72 mm







### HALO DOWN

Capacity	3,00 W
Installation value	5,00 VA
Colour temperature	3000 K
CRI	92
IP	55
Colour	■
Height	100 mm



### HALO UP-DOWN

Capacity	6,50 W
Installation value	10,00 VA
Colour temperature	3000 K
CRI	92
IP	55
Colour	■
Height	120 mm



### HALO DOWN 100-230V

Capacity	4,50 W
Installation value	11,50 VA
Colour temperature	3000 K
CRI	92
IP	55
Colour	■
Height	100 mm

\*This fixture is dimmable



### HALO UP-DOWN 100-230V

Capacity	8,50 W
Installation value	20,00 VA
Colour temperature	3000 K
CRI	93
IP	55
Colour	■
Height	100 mm

\*This fixture is dimmable





### WEDGE SLIM

Capacity 1,00 W  
 Installation value 1,00 VA  
 Colour temperature 2800 K  
 CRI 96  
 IP 55  
 Colour   
 Width 200 mm

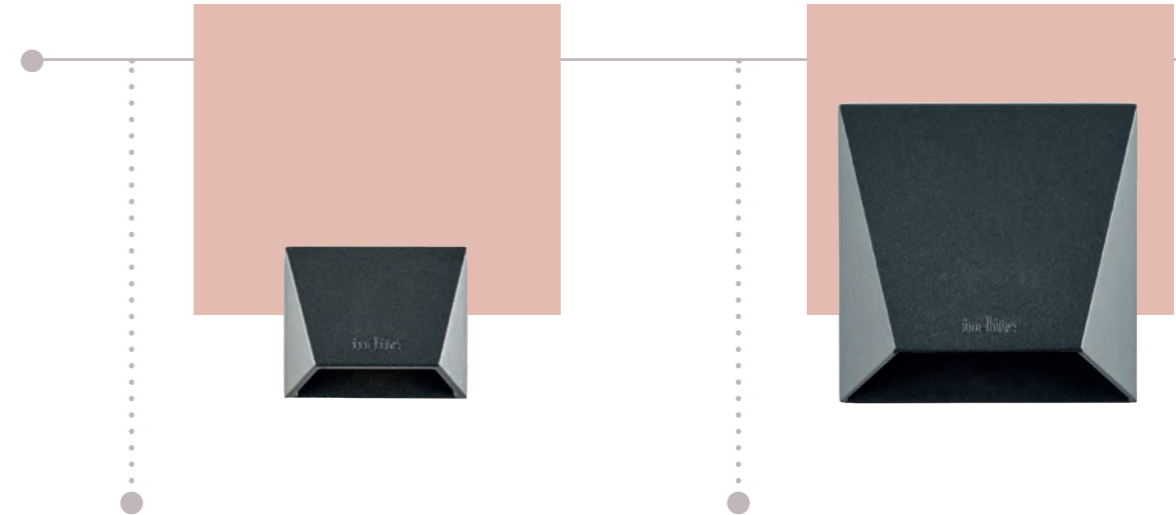
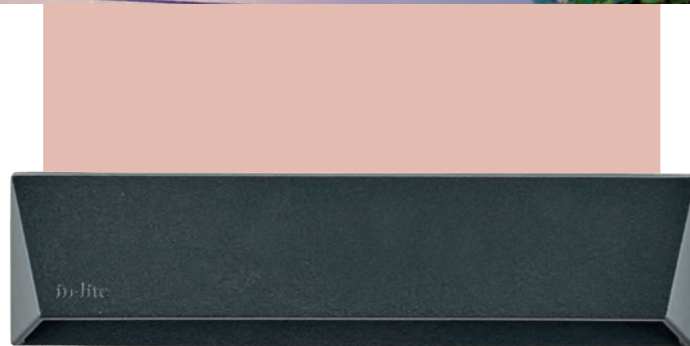

### MINI WEDGE

Capacity 0,60 W  
 Installation value 0,60 VA  
 Colour temperature 2900 K  
 CRI 95  
 IP 55  
 Colour   
 Width 60 mm

### WEDGE

Capacity 1,00 W  
 Installation value 1,60 VA  
 Colour temperature 2800 K  
 CRI 94  
 IP 55  
 Colour   
 Width 63 mm







**BLINK**

Capacity 1,00 W  
 Installation value 1,70 VA  
 Colour temperature 2800 K  
 CRI 95  
 IP 55  
 Colour   
 Size ø100 mm



**MINI SWAY WALL**

Capacity 0,50 W  
 Installation value 0,60 VA  
 Colour temperature 2900 K  
 CRI 96  
 IP 55  
 Colour   
 Size ø50 mm

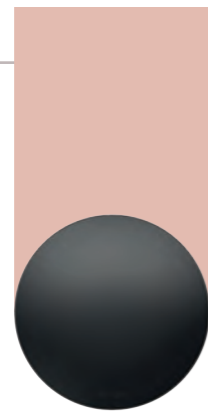

**SWAY WALL**

Capacity 1,00 W  
 Installation value 1,00 VA  
 Colour temperature 2900 K  
 CRI 95  
 IP 55  
 Colour   
 Size ø85 mm

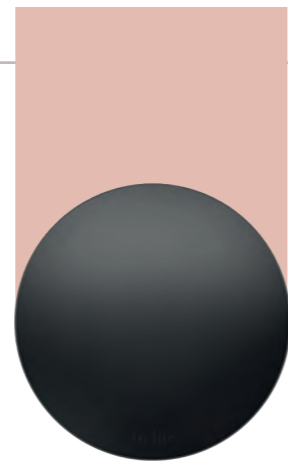



# WALL LIGHTS

## LIGHT

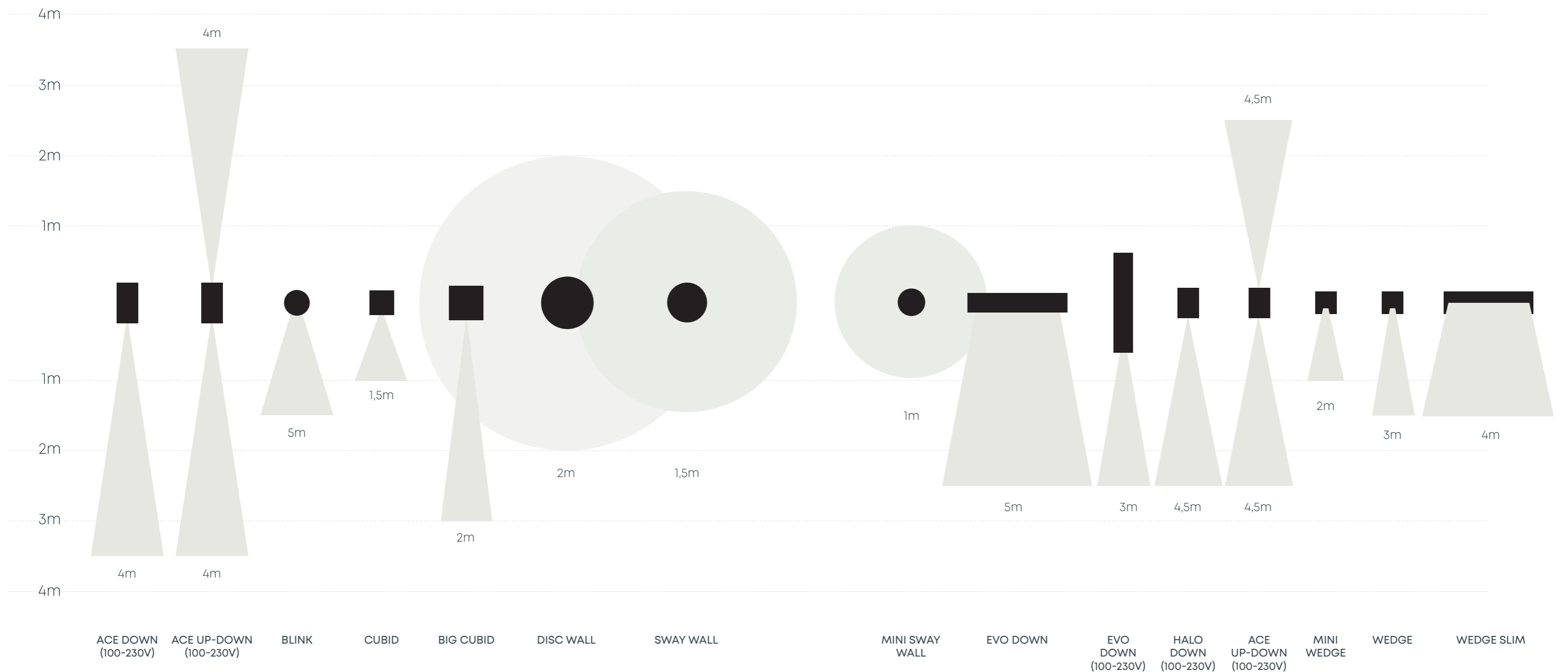



PRODUCT GROUP

# CEILING LIGHTS

## SCOPE CEILING

Light intensity: medium

## DISC PENDANT

Light intensity: low

## SWAY PENDANT

Light intensity: high

## VOQUE PENDANT

Light intensity: high



## MINI SCOPE CEILING

Capacity	1,00 W
Installation value	2,00 VA
Colour temperature	2900 K
CRI	93
IP	67
Size	ø47 mm



## SCOPE CEILING

Capacity	3,00 W
Installation value	4,80 VA
Colour temperature	3100 K
CRI	91
IP	67
Size	ø66 mm





### AIM CEILING

Capacity 1,20 W  
 Installation value 2,10 VA  
 Colour temperature 2900 K  
 CRI 90  
 Height 85 mm



### VOQUE PENDANT

Capacity 3,00 W  
 Installation value 5,20 VA  
 Colour temperature 2750 K  
 CRI 89  
 IP 55  
 Size ø300 mm

\*Adjustable in length from 55 to 98 cm



### BIG VOQUE PENDANT

Capacity 5,00 W  
 Installation value 8,00 VA  
 Colour temperature 2750 K  
 CRI 89  
 IP 55  
 Size ø450 mm

\*Adjustable in length from 55 to 98 cm







### SWAY PENDANT

Capacity 0,90 W  
 Installation value 1,00 VA  
 Colour temperature 2900 K  
 CRI 96  
 IP 55  
 Colour    
 Size ø85 mm

### SWAY PENDANT 100-230V

Capacity 2,50 W  
 Installation value 7,10 VA  
 Colour temperature 2900 K  
 CRI 96  
 IP 55  
 Colour    
 Size ø85 mm

**in-lite** | human dimming



Personalise the SWAY fixtures with in-lite accessories specially developed to enable you to play with light. Any illumination you like can be created with these accessories.

SWAY PENDANT CAP



### DISC PENDANT

Capacity 3,00 W  
 Installation value 4,90 VA  
 Colour temperature 2900 K  
 CRI 98  
 IP 55  
 Colour   
 Size ø200 mm

### DISC PENDANT 100-230V

Capacity 4,50 W  
 Installation value 11,80 VA  
 Colour temperature 2900 K  
 CRI 98  
 IP 55  
 Colour   
 Size ø200 mm

**in-lite** | human dimming



# CREATING GARDENS

IN PHASES

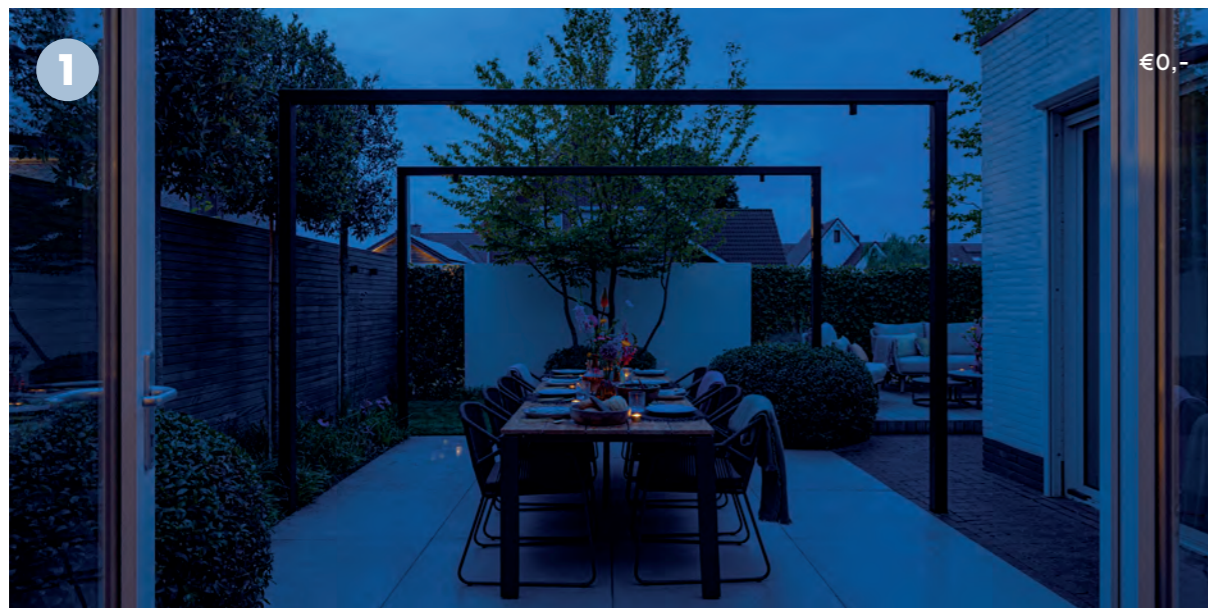

The unique in-lite system makes it possible to expand your lighting step by step. You start by installing a sufficient number of cables in the garden and over time, you simply add new fixtures as desired. Your dream garden will be a reality in no time!





# IN-LITE X PARTNERS

Cooperation is a top priority for in-lite. Joining forces and creating unique gardens together. Anything to make outdoor living more appealing and more pleasurable. Somewhere to enjoy your garden in a different way each season.

For many years now, in-lite has had a solid partnership with MBI. MBI's GeoCeramica® is the ideal choice for high-quality, maintenance-free, easy-to-install ceramic paving. Add integrated lighting from in-lite and you will be able to enjoy your garden night and day.

Adezz's planters are in-lite-ready. CARREZ and CIRCUM are the first products of this unique collaboration. The planters come with a profile into which in-lite's SMART EVO FLEX LED strip can easily be embedded. Thus creating a single elegant unit that will add a unique dimension to your garden.

Last year saw in-lite and Big Green Egg team up to release a fixture together. It has been a success. And that's an understatement! Our renowned SWAY TABLE has been given a makeover. Are you a true Big Green Egg fan? Then hurry and add this to your collection.



Big Green Egg

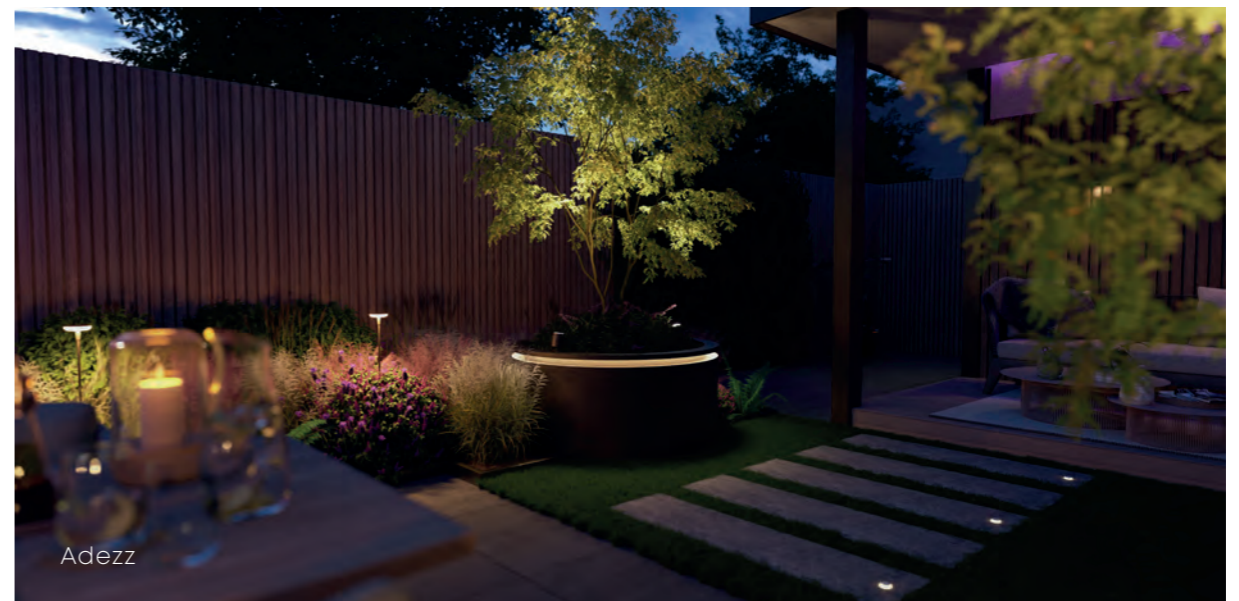

Adezz



MBI





# SYSTEM

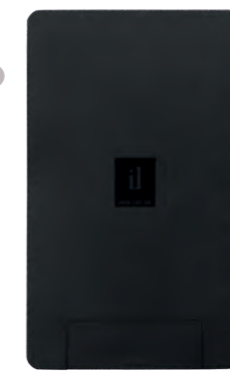

## HUB-50

A high-quality transformer with touch screen operation and maximum installation value of 50 VA, equipped with two lines that can be controlled jointly.

## HUB-100

A high-quality transformer with touch screen operation and maximum installation value of 100 VA, equipped with two lines that can be controlled jointly.

## SMART HUB-150

SMART HUB-150 has an installation value of 150 VA and comes with three lines that can be controlled individually using the in-lite app.

## SMART HUB-300

SMART HUB-300 has an installation value of 300 VA and comes with three lines that can be controlled individually using the in-lite app.

	50VA	100VA	150VA	300VA
Maximum connection value	50VA	100VA	150VA	300VA
Can be controlled using	Touch screen	Touch screen	App	App
Cable outlets	2	2	3	3
Lines can be controlled separately	✗	✗	✓	✓
Switching on/off	Touch screen	Touch screen	Button & App	Button & App
Connecting smart lighting	✗	✗	✓	✓
Works with SMART BRIDGE	✗	✗	✓	✓
Maximum cable length when using 10/2	80m	80m	80m	160m*

\*At max. load of 130VA per cable



## HUBS <sup>1</sup>

HUB is a transformer that controls the garden lighting. A choice of four different hubs is available: HUB-50, HUB-100 and SMART HUB-150 and SMART HUB-300. Add up the VA value of your lighting to find out which transformer will suit your garden.

## CABLES <sup>2</sup>

The cable can be rolled out from the transformer and guided along the fixtures. There are two types of cables available: 14/2 and 10/2.

## CABLE SPLITTING <sup>3</sup>

Want to split or branch a cable? Use a cable connector (CC-2) to split the cable plan in no time.



## INSTALLATION INSTRUCTIONS

Install HUB at least 50 cm from the ground - away from precipitation - such as indoors, in a shed or under a canopy. If you do wish to site your HUB outdoors, always use a PROTECTOR. In the absence of a PROTECTOR the warranty will be invalidated.

## EASY-LOCK <sup>4</sup>

Every fixture comes with an EASY-LOCK. This is used to connect the fixture at any point along the main cable.

## ACCESSORIES <sup>5</sup>

Is an in-lite fixture's cable too short? Simply use the extension cords. Another useful accessory is the splitter, which lets you connect two fixtures to one extension cord.

## CABLE ENDS <sup>6</sup>

The cable can end anywhere in the garden and does not need to form a closed system. Seal off the end of the cable with the cover caps provided to ensure that no moisture can get in and that the cable ends do not come into contact with one another. Thus preventing short-circuiting.

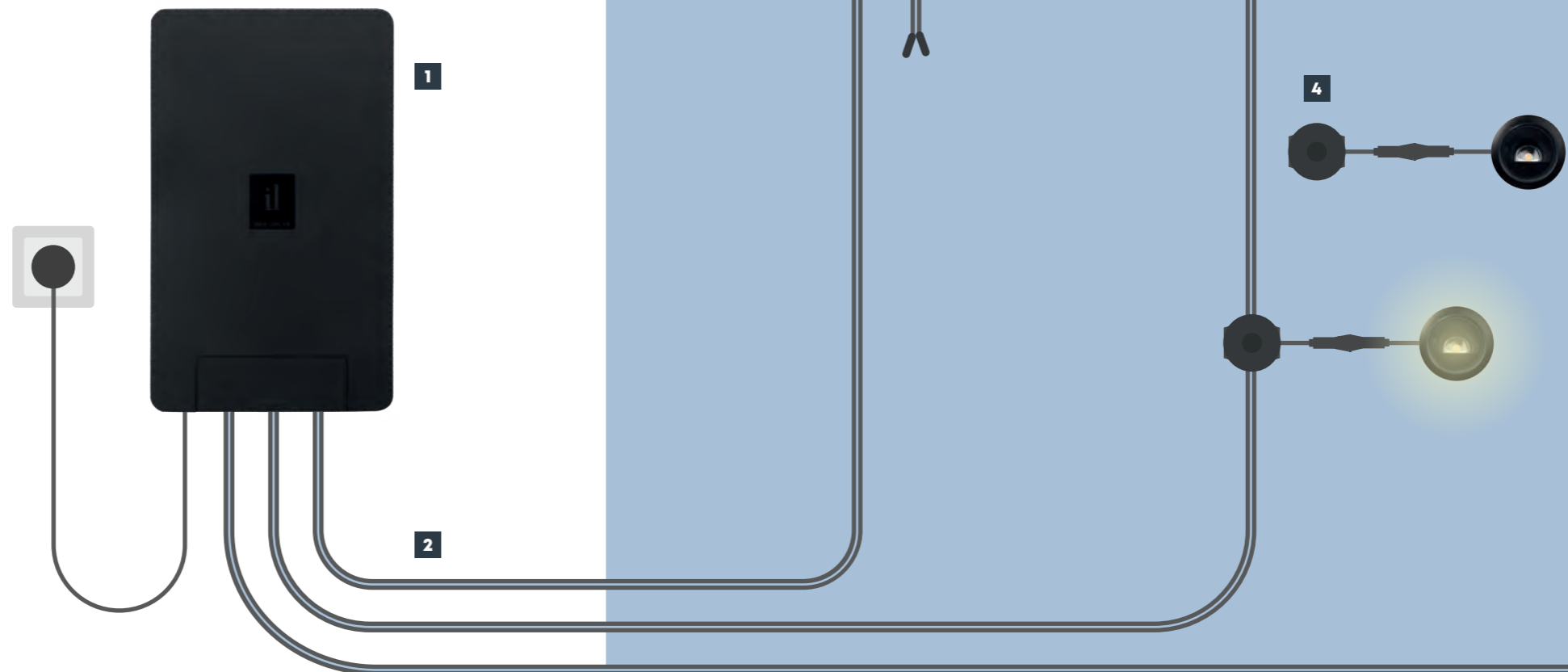



# ACCESSORIES

## FOR THE SYSTEM

Got a great lighting plan for your garden and worried that you won't be able to buy it all at once? Expanding your plan step by step is easy. You start by installing sufficient cabling in the garden and over time, you simply add new fixtures as desired. Your dream garden will be a reality in no time!



### SMART EXTENDERS

This Smart product has been developed to improve the Bluetooth signal in and around your home. In some homes, external factors like thickly insulated walls and steel structures make Bluetooth connections suboptimal. The quality of the different Bluetooth receivers in smartphones currently in circulation varies widely too. SMART EXTENDER will improve your connection in such situations.

### SMART BRIDGE

SMART BRIDGE is an in-lite SMART system accessory that creates a bridge to the internet. The Internet connection makes it possible to integrate the in-lite SMART system into 'Smart Home' systems such as Google Home, Apple HomeKit and Amazon Alexa. The lighting can also be activated by means of voice commands, for instance. Simply connect your Smart Home system.



### HUB PROTECTORS

SMART HUB PROTECTOR has been developed to provide the refined technology in the SMART HUB-150 transformer with even better protection. This accessory will extend the lifespan of the product if it will not be possible to install the SMART HUB-150 somewhere covered. If you do install the transformer outside without a PROTECTOR, the warranty will be invalidated.



### MOTION DETECTORS

Just like the SMART HUB, the wireless SMART MOVE can be controlled via Bluetooth connection using the in-lite app. The time for which the lighting stays on after motion is detected is adjustable by the minute from 1 to 60 minutes using the in-lite app.

### TOUCH DIMMER

Keen to effortlessly adjust the intensity of your wall lights and hanging lights? Then discover the TOUCH DIMMER. This handy accessory will enable you to dim any outdoor light individually, with four different light settings to choose from. And best of all, you do not need a SMART system for the TOUCH DIMMER, making ease of use accessible.





# WELCOME IN THE IN-LITE PLAYGROUND

Be inspired by what in-lite can do to make your  
outdoor space unique. Enjoy the magic.



## CUSTOMER SERVICE **EXTRAORDINARY**

Please feel free to put any questions you may have about in-lite products, installation and warranty to our experienced customer service team. They will be happy to help to ensure that you are able to enjoy your elegantly lit outdoor space each and every day. Looking for further inspiration? Then check out our social media channels and our website.

Telephone number: **+31 (0)184 688 760**  
E-mail address: **customerservice@in-lite.nl**  
Chat function: **www.in-lite.nl**  
Social Media: **Instagram: @inlite\_global**  
**Facebook: @inlitenl**  
**Pinterest @inliteglobalHQ**



### Own a unique outdoor space and looking for advice?

Our aim is to illuminate every outdoor space as uniquely, creatively and magically as possible. We design elegant lighting plans for the largest private gardens, terraces of hotels or restaurants and semi-public outdoor spaces. If an on-site lighting demo is required, LAB is the team to take care of this.

### EXPERIENCE IN-LITE AT OUR DEALERSHIPS

Got your bearings now and keen to see and experience the products? Then visit one of our outlets. Scan the QR code and find a dealership in your local area.





# INDEX

<b>A</b>		<b>H</b>	
ACE	59	HALO DOWN	73
ACE DOWN	68	HALO DOWN 100-230V	73
ACE DOWN 100-230V	68	HALO UP-DOWN	73
ACE HIGH	59	HALO UP-DOWN 100-230V	73
ACE UP-DOWN	68	HUB-50	91
ACE UP-DOWN 100-230V	68	HUB-100	91
		HYVE	23
<b>B</b>		HYVE 22	23
BIG CUBID	70	HYVE 22 RVS	23
BIG FLUX	27		
BIG FLUX NARROW	27	<b>L</b>	
BIG FLUX ASYMMETRIC	27	LIV	61
BIG NERO	31	LIV LOW	61
BIG NERO NARROW	31	LUNA	25
BIG SCOPE	41		
BIG SCOPE NARROW	41	<b>M</b>	
BLINK	77	MINI SCOPE	39
		MINI SCOPE CEILING	81
<b>C</b>		MINI SCOPE DUO	44
CUBID	70	MINI SWAY	56
		MINI SWAY WALL	76
<b>D</b>		MINI WEDGE	75
DB-LED (WW)	24		
DISC	60	<b>N</b>	
DISC LOW	60	NERO	30
DISC PENDANT	85		
DISC PENDANT 100-230V	85	<b>P</b>	
DISC WALL	67	PUCK	21
DISC WALL 100-230V	67	PUCK 22	21
<b>E</b>		<b>R</b>	
EVO	63	RISER	41
EVO DOWN	71		
EVO DOWN 100-230V	71	<b>S</b>	
EVO FLEX	50	SCOPE	41
EVO FLOOD	32	SCOPE CEILING	81
EVO GROUND 300	33	SMART HUB-150	91
EVO HYDE 180	49	SPIKE	26
EVO HYDE 550	49	SUB	45
EVO LOW	63	SWAY	56
		SWAY PENDANT	84
<b>F</b>		SWAY PENDANT 100-230V	84
FLUX	26	SWAY TABLE	55
FUSION	22	SWAY WALL	76
FUSION 22	22		
FUSION 22 RVS	22	<b>W</b>	
		WEDGE	75
		WEDGE SLIM	74

**This brochure is distributed free of charge through in-lite's dealership network. An up-to-date overview of our sales outlet locations can be found at [in-lite.nl](http://in-lite.nl).**

No rights may be derived from the information provided in this publication. All specifications are subject to typesetting and printing errors. Colours may vary.

**Photography**  
Dion Doornik  
Roel van der Aa

**Design**  
Brand Creatives

**Image editing**  
MarkMyWork



